

AKUSTIK LATERAL NONIUS + SYLOMER®



These acoustic hangers have been conceived for the suspension of false ceilings, vibrating pipelines and machinery that has to be suspended.

The excellent properties of the Sylomer® microcellular polyurethane material achieve elevated isolation values as opposed to other mounts that use rubber or cork, or a combination of both. These antivibration mounts are manufactured in two special mixes of Sylomer® to adapt better to the load of each application.

A great variety of fixing metal armors and elements facilitate the installation and to adapt better to each type of job. Their rugged metal parts can withstand tensile stresses from 650Kg to 1000Kg. They are supplied with an anticorrosive treatment that can withstand the toughest environments.



DRAWINGS

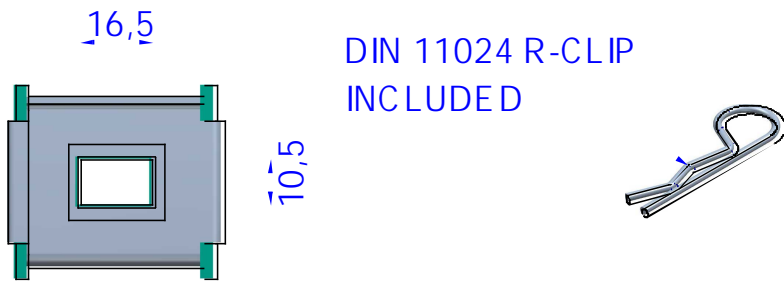
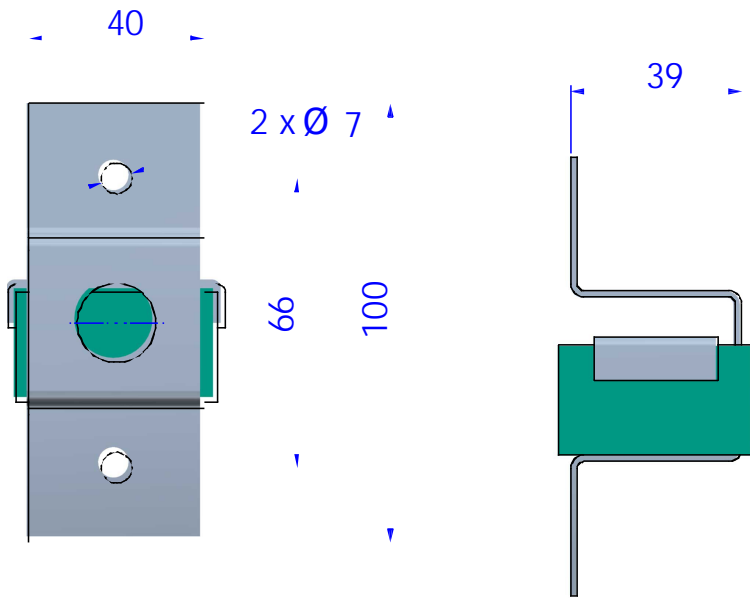

DIMENSIONS

Type	Code
Akustik Lateral Nonius + Sylomer®15	23677
Akustik Lateral Nonius + Sylomer®30	23679
Akustik Lateral Nonius + Sylomer®50	23681

Elastical properties

LOAD-DEFLECTION GRAPH

Akustik + Sylomer 15

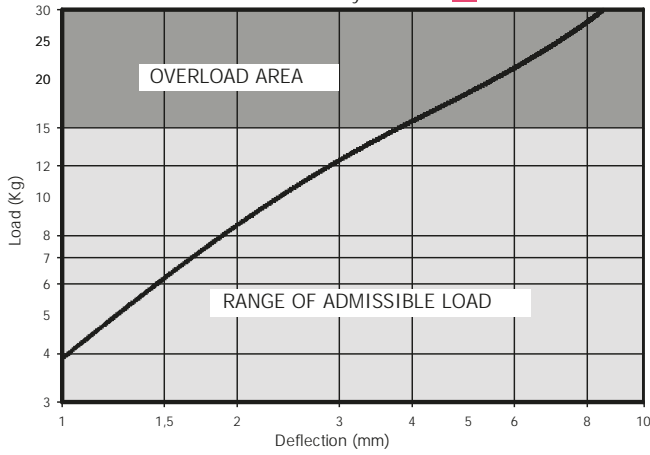

NATURAL FREQUENCY GRAPHS

Akustik + Sylomer 15

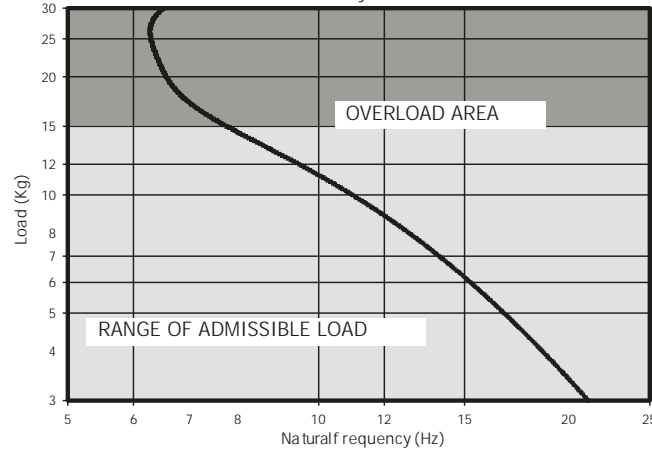

Akustik + Sylomer 30

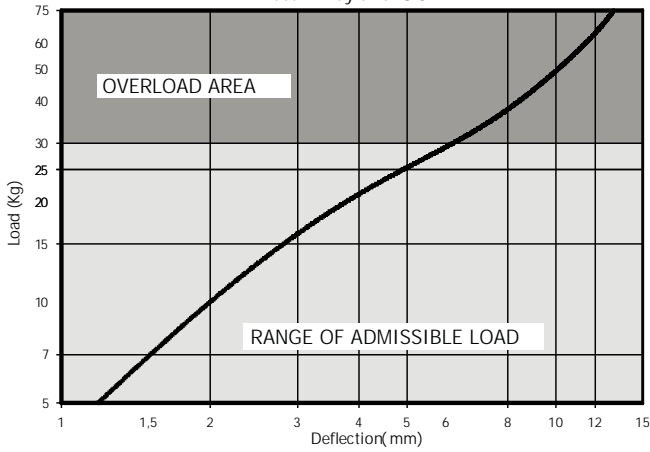

Akustik + Sylomer 30

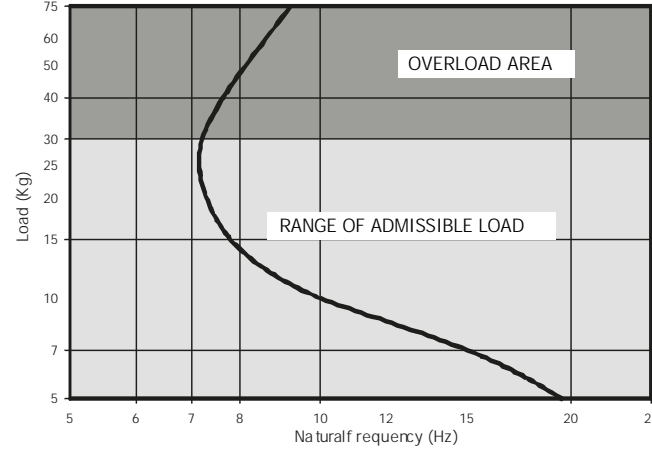

Akustik + Sylomer 50

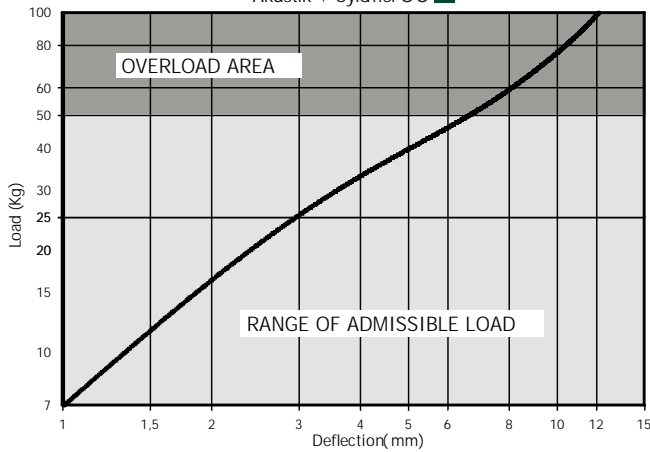

Akustik + Sylomer 50

